

ONE MANUFACTURER. MANY SOLUTIONS.

WORK AREA OUTLETS

CAT6A KEYSTONE JACKS [HDJ SERIES / SINGLE PACK]

WH
BL

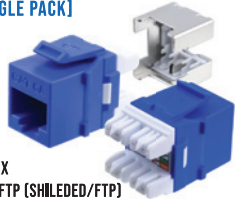

- PART NO. HD-6AKSJXX
- PART NO. HD-6AKSJ-FTP (SHIELED/FTP)
- 110-TYPE, 8P8C, RJ-45, T568A/B WIRING
- 180-Degree configuration for fast punch down
- Component-Rated performance

CAT6A KEYSTONE JACKS [HDJ SERIES / 25-PACK]

WH
BL
YL
BK



- PART NO. HD-6AKSJXX-25PK
- 110-TYPE, 8P8C, RJ-45, T568A/B WIRING
- 180-Degree configuration for fast punch down
- Component-Rated performance

CAT6A KEYSTONE JACKS [SDJ SERIES / SINGLE PACK]

WH
BL



- PART NO. 6AKSJXX
- 110-TYPE, 8P8C, RJ-45, T568A/B WIRING
- 90-Degree configuration for fast punch down
- Component-Rated performance

CAT6A KEYSTONE JACKS [SDJ SERIES / 25-PACK]

WH
BL
YL
BK



- PART NO. 6AKSJXX-25PK
- 110-TYPE, 8P8C, RJ-45, T568A/B WIRING
- 90-Degree configuration for fast punch down
- Component-Rated performance

CAT6 KEYSTONE JACKS [HDJ SERIES / SINGLE PACK]

WH RD
BL OR
IV YL
GN BK
LA



- PART NO. HD-6KSJXX
- 110-TYPE, 8P8C, RJ-45, T568A/B WIRING
- 180-Degree configuration for fast punch down
- Component-Rated performance

CAT6 KEYSTONE JACKS [HDJ SERIES / 25-PACK]

WH
BL
YL
BK



- PART NO. HD-6KSJXX-25PK
- 110-TYPE, 8P8C, RJ-45, T568A/B WIRING
- 180-Degree configuration for fast punch down
- Component-Rated performance

CAT6 KEYSTONE JACKS [SDJ SERIES / SINGLE PACK]

WH RD
BL OR
IV YL
GN BK
LA PR



- PART NO. 6KSJXX
- 110-TYPE, 8P8C, RJ-45, T568A/B WIRING
- 90-Degree configuration for fast punch down
- Component-Rated performance

CAT6 KEYSTONE JACKS [SDJ SERIES / 25-PACK]

WH
BL
YL
BK



- PART NO. 6KSJXX-25PK
- 110-TYPE, 8P8C, RJ-45, T568A/B WIRING
- 90-Degree configuration for fast punch down
- Component-Rated performance

CAT5E KEYSTONE JACKS [HDJ SERIES / SINGLE PACK]

WH RD
BL OR
IV YL
GN BK
LA



- PART NO. HD-5EKSJXX
- 110-TYPE, 8P8C, RJ-45, T568A/B WIRING
- 180-Degree configuration for fast punch down
- Component-Rated performance

CAT5E KEYSTONE JACKS [HDJ SERIES / 25-PACK]

WH
BL
YL
BK



- PART NO. HD-5EKSJXX-25PK
- 110-TYPE, 8P8C, RJ-45, T568A/B WIRING
- Accepts standard keystone port openings
- Component-Rated performance

CAT5E KEYSTONE JACKS [SDJ SERIES / SINGLE PACK]

WH RD
BL OR
IV YL
GN BK
LA



- PART NO. 5EKSJXX
- 110-TYPE, 8P8C, RJ-45, T568A/B WIRING
- 90-Degree configuration for fast punch down
- Component-Rated performance

CAT5E KEYSTONE JACKS [SDJ SERIES / 25-PACK]

WH
BL
YL
BK



- PART NO. 5EKSJXX-25PK
- 110-TYPE, 8P8C, RJ-45, T568A/B WIRING
- 90-Degree configuration for fast punch down
- Component-Rated performance

CAT3 KEYSTONE JACKS [SDJ SERIES / SINGLE PACK]

WH
IV
LA



- PART NO. 3EKSJXX
- 110-TYPE, 6P6C, RJ-11/RJ-12, USOC/UTP
- 90-Degree configuration for fast punch down
- Designed for voice applications

HDMI KEYSTONE STYLE FEEDTHROUGH COUPLERS



- PART NO. WHDMI-WH
- HDMI-TO-HDMI keystone style feedthrough
- Accepts standard keystone port openings
- Ideal for coupling multiple HDMI cables

CAT6 KEYSTONE STYLE FEEDTHROUGH COUPLERS [SINGLE PACK]

WH
BK



- PART NO. 6KSCXX1
- Snap-In, Keystone style, RJ-45
- Accepts standard keystone port openings
- Component-Rated performance

CAT6 KEYSTONE STYLE FEEDTHROUGH COUPLERS [25-PACK]

WH
BK



- PART NO. 6KSCXX25
- Snap-In, Keystone style, RJ-45
- Accepts standard keystone port openings
- Component-Rated performance

SNAP-IN F-TYPE GOLD & NICKEL PLATED 3GHZ F/F KEYSTONE INSERT MODULES [SINGLE PACK]

WH
IV

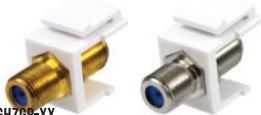

- PART NO. FTK-3GHZGP-XX
- PART NO. FTK-3GHZNP-XX
- Snap-in keystone style compatible with faceplates, blank patch panels and surface mount boxes
- 3GHZ gold-plated and nickel plated ideal for CATV, SATV, Antennas and other video applications

SNAP-IN F-TYPE GOLD & NICKEL PLATED 3GHZ F/F KEYSTONE INSERT MODULES [25-PACK]

WH
IV



- PART NO. FTK-3GHZGP-XX-25PK
- PART NO. FTK-3GHZNP-XX-25PK
- Snap-in keystone style compatible with faceplates, blank patch panels and surface mount boxes
- 3GHZ gold-plated and nickel plated ideal for CATV, SATV, Antennas and other video applications

GOLD-PLATED SPEAKERS BINDING POST MODULES

WH
IV



- PART NO. KSBP-BRPAIR-XX
- Ideal for banana plugs, speaker tips, spade tips or bare wire
- Compatible with faceplates, blank patch panels and SMBs
- Packaged in pair red & black color code

BNC 75 OHM KEYSTONE STYLE MODULES

WH
IV



- PART NO. KSJBN75-XX
- Compatible with faceplates, blank patch panels and SMBs
- Female-female BNC feedthrough connector
- 75 Ohm impedance, nickel-plated finish

WORK AREA OUTLETS

FLUSH MOUNTING STYLE WITHOUT ID WINDOWS FACEPLATES

WH
IV
LA



- PART NO. FPO1PXX
- PART NO. FPO2PXX
- PART NO. FPO3PXX
- PART NO. FPO4PXX
- PART NO. FPO6PXX

- PART NO. FPO1PXX-25PK
- PART NO. FPO2PXX-25PK
- PART NO. FPO3PXX-25PK
- PART NO. FPO4PXX-25PK
- PART NO. FPO6PXX-25PK

- PART NO. FPO0PXX
- PART NO. FPO0D6XX
- PART NO. FPO0BXX

- Single & double gang
- Flush mount design for professional aesthetic look
- Matte finish with rugged and durable construction



FLUSH MOUNTING STYLE WITH ID WINDOWS FACEPLATES

WH
IV



- PART NO. FPW1PXX
- PART NO. FPW2PXX
- PART NO. FPW3PXX
- PART NO. FPW4PXX
- PART NO. FPW6PXX

- PART NO. FPW1PXX-25PK
- PART NO. FPW2PXX-25PK
- PART NO. FPW3PXX-25PK
- PART NO. FPW4PXX-25PK
- PART NO. FPW6PXX-25PK

- ID windows with enclosed labels and clear plastic covers
- 1-6 Ports with color-matched screws
- Single-gang accepts standard metal or plastic outlet boxes
- Matte finish with rugged and durable construction
- Fits standard rectangular NEMA openings



FLUSH MOUNTING STYLE OVERSIZED FACEPLATES

WH
IV



- PART NO. OSWP01XX
- PART NO. OSWP02XX
- PART NO. OSWP03XX
- PART NO. OSWP04XX
- PART NO. OSWP06XX

- 1-6 Port with color-matched screws
- Offers greater coverage to hide wall irregularities
- Flush mount design for professional aesthetic look
- Glossy finish with rugged and durable construction
- Fits standard rectangular NEMA openings

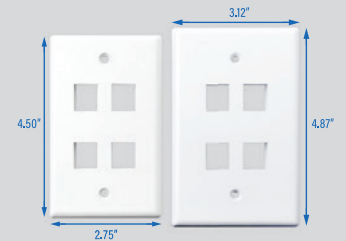

STANDARD SIZE OVERSIZED

FLUSH MOUNTING STYLE STAINLESS STEEL FACEPLATES

SS



- PART NO. SAFP-01P
- PART NO. SAFP-02P
- PART NO. SAFP-03P
- PART NO. SAFP-04P
- PART NO. SAFP-06P
- PART NO. SAFP-06P-D
- PART NO. SAFP-012P-D

- Brushed stainless steel finish to provide corrosion resistant
- Suitable for durability and sanitary environment requirements
- Ideal for residential and commercial applications
- Flush mounting style for seamless aesthetic look

Double-Gang

DECORA STYLE MULTIMEDIA INSERTS AND WALLPLATES

WH
IV

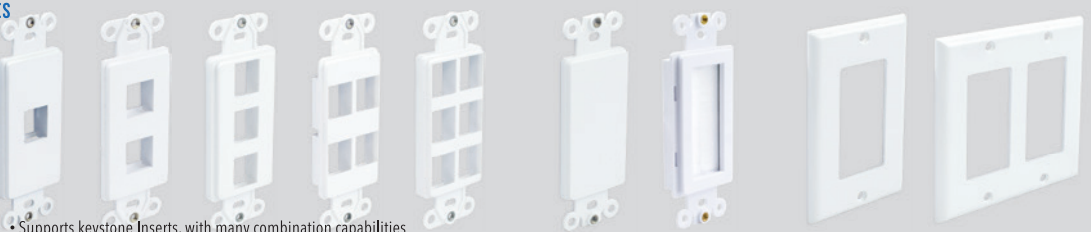

- PART NO. DWIN-1P-XX
- PART NO. DWIN-2P-XX
- PART NO. DWIN-3P-XX
- PART NO. DWIN-4P-XX
- PART NO. DWIN-6P-XX

- PART NO. DWIN-BR-WH
- PART NO. DWPBI-XX
- PART NO. DWP16-XX
- PART NO. DWP26-XX

- Supports keystone Inserts, with many combination capabilities
- Fits Decora style single-gang and double-gang faceplates
- Contemporary style ideal for residential or commercial installations
- Glossy finish with rugged and durable construction

SURFACE MOUNTING BOXES

WH
IV



- PART NO. SMB-1XX
- PART NO. SMB-2XX
- PART NO. SMB-4XX
- PART NO. SMB-6XX

- 1/2/4/6-Port, Unloaded, Configurable
- Suitable for surface mounting applications
- Compatible with modular keystone connectors
- Includes two self-tapping screws and double-sided adhesive tape

RECESSED TELEPHONE WALLPLATES PLASTIC & STAINLESS STEEL

WH
SS



- PART NO. WPP01WH
- PART NO. WPP01SS
- Designed to wall mount telephone on wall
- Compatible with universal modular keystone jacks
- Rivet feature support variety of wall mount telephones

FLUSH MOUNTING STYLE INTEGRATED FACEPLATE CAT6 DATA & F-TYPE PORTS

WH



- PART NO. 1CAT61F-WH
- 1-Port CAT6 & 1-Port 3GHZ F-TYPE faceplate
- UL Listed & Compliant with ANSI/TIA-568-C.2
- 110-IDC punch down style for performance and reliability

FIBER OPTIC SYSTEM

FIBER OPTIC RACK MOUNT ENCLOSURE



FRONT

- PART NO. FRM3M1U
- 3-Panel, 1U, 19" X 8.50", w/ Two Splice Trays & Cable Slack Spools

WALL MOUNT FIBER ENCLASURE

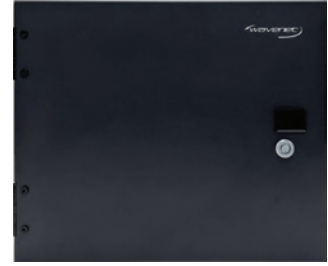

- PART NO. WMFO-4P
- 4-Panel, 2pcs./splice small trays

FIBER OPTIC ADAPTER PANELS

- PART NO. FM12LCOM3 • 12-Port, Duplex, LC, MM, OM3
- PART NO. FM24LCOM3 • 24-Port, Quad, LC, MM, OM3
- PART NO. FM6SCOM3 • 6-Port, Simplex, SC, MM, OM3
- PART NO. FM12SCOM3 • 12-Port, Duplex, SC, SM, OS2
- PART NO. FM6ST • 6-Port, Simplex, ST, MM, OM2
- PART NO. FM12LCS2 • 12-Port, Duplex, LC, SM, OS2

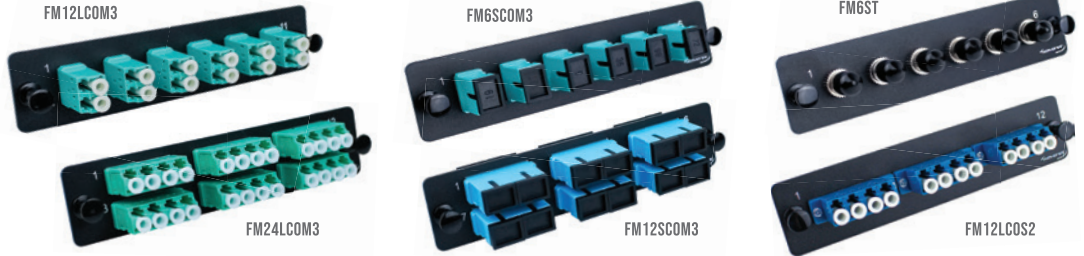

FIBER OPTIC KEYSTONE STYLE COUPLERS

- PART NO. FOKSALCWH • LC Duplex, Zirconia Ceramic Sleeve • OM3, MM, Aqua, LC Adapter
- PART NO. FOKSBLCWH • LC Duplex, Zirconia Ceramic Sleeve • OS2, SM, Blue, LC Adapter
- PART NO. FOKSBCSWH • SC Simplex, Zirconia Ceramic Sleeve • SM, MM, Aqua, SC Adapter w/ Shutter

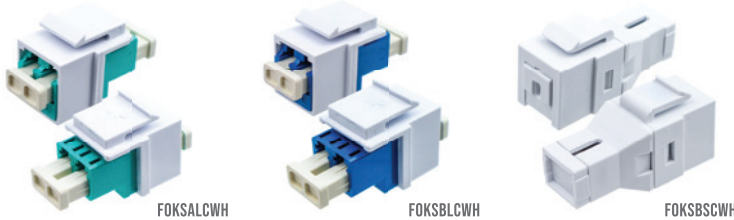

FIBER OPTIC BLANK PLATE



- PART NO. FMBP
- Blank Plate, Black

PATCH PANELS

CAT6A 110-TYPE PATCH PANELS



24-PORT

- PART NO. 6APP24
- PART NO. 6APP48
- PoE Type 4 compliance for applications up to 100W
- Meet and exceeds ANSI/TIA-568.2-D, UL Listed
- Foldable cable management bar included w/ each panel

CAT6 110-TYPE PATCH PANELS



24-PORT

12-PORT

- PART NO. 6EPP12V • 12-Port, T568A/B wiring, Wall mountable w/ 89D bracket
- PART NO. 6EPP24 • 1U/24-port, 2U/48-port, 110-TYPE, T568A/B wiring
- PART NO. 6EPP48 • Meet and exceeds ANSI/TIA-568-C, UL listed

CAT5E 110-TYPE PATCH PANELS



24-PORT

12-PORT

- PART NO. 5EPP12V • 12-Port, T568A/B wiring, Wall mountable w/ 89D bracket
- PART NO. 5EPP24 • 1U/24-port, 2U/48-port, 110-TYPE, T568A/B wiring
- PART NO. 5EPP48 • Meet and exceeds ANSI/TIA-568-C, UL listed

BLANK PATCH PANEL



24-PORT

48-PORT

12-PORT

- PART NO. BPPWM-12 • 12-Port, Wall mount, Compatible with keystone style connectors, Rotatable Modules
- PART NO. BPPWM-24 • 1U, 24-Port, w/ Labeling areas, Compatible with keystone style connectors
- PART NO. BPPWM-48 • 2U, 48-Port, w/ Labeling areas, Compatible with keystone style connectors

ANGLED BLANK PATCH PANELS



24-PORT

48-PORT

- PART NO. ABP1U-24P
- PART NO. ABP1U-48P
- Angled design saves rack space by routing patch cords directly into vertical cable managers
- Accommodates [1U/24-port, 1U/48-port] keystone style snap-in modular connectors
- Include rear cable management bar for proper cable support

CAT6A/6/5E SHIELDED FTP PATCH PANELS



- PART NO. BPPWM-24 [24] HD-6AKSJ-FTP
- PART NO. BPPWM-48 [48] HD-6AKSJ-FTP

CAT6A/6/5E PATCH CORDS



CAT6A



CAT6



CAT5E

- PART NO. 6A04UMXX-PC-XX
- PART NO. 6E04UMXX-PC-XX
- PART NO. 5E04UMXX-PC-XX
- 100% Copper Wire, EIA/TIA TSB-40A ETL verified, CM-Rated
- CAT6A / CAT6 : LENGTH(XX) 6 inch and rest in feet 1,2,3,5,6,7,10,14,15,20,25,30,35 in blue only, 50,75,100
- CAT5E : LENGTH(XX) 6 inch and rest in feet 1,2,3,5,7,10,14,15,25,35,50,75,100

CABINETS & RACKS

6U / 9U / 12U / 15U / 18U WALL MOUNT CABINETS

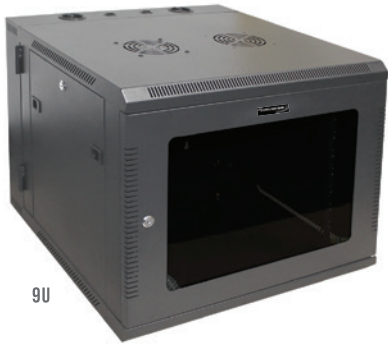

9U

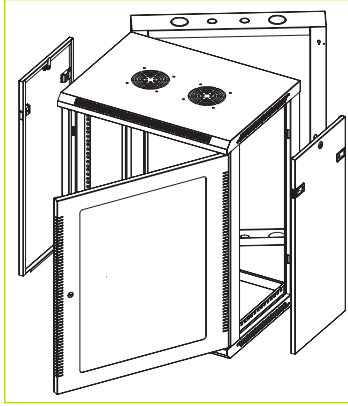

PART#	U SIZE	WIDTH	HEIGHT	DEPTH	USABLE DEPTH	LOAD CAPACITY	FAN	RAILS
CBTF-WM6U	6U	23.6"	14.6"	23.6"	18.0"	66 LBS.	1	#12-24 OR #10-32
CBTF-WM9U	9U	23.6"	19.8"	23.6"	18.0"	73 LBS.	1	
CBTF-WM12U	12U	23.6"	25.0"	23.6"	18.0"	79 LBS.	1	
CBTF-WM15U	15U	23.6"	30.3"	23.6"	18.0"	86 LBS.	1	
CBTF-WM18U	18U	23.6"	35.6"	23.6"	18.0"	93 LBS.	1	

27U / 42U STANDING SERVER CABINETS



42U

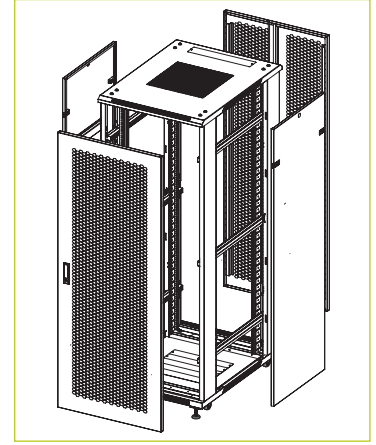

PART#	U SIZE	WIDTH	HEIGHT	DEPTH	USABLE DEPTH	LOAD CAPACITY	FAN	RAILS
CBTF-FL27U-32	27U	23.6"	54.4"	31.5"	27.0"	1764 LBS.	1 TRAY WITH 4 FANS	#12-24 STANDARD
CBTF-FL42U-32	42U	23.6"	80.9"	31.5"	27.0"	1764 LBS.		M6 CAGE NUT
CBTF-FL27U-40	27U	23.6"	54.4"	39.4"	35.0"	1764 LBS.		
CBTF-FL42U-40	42U	23.6"	80.9"	39.4"	35.0"	1764 LBS.		

8U / 15U / 30U OPEN FRAME WALL RACKS



8U

15U

30U

PART#	U SIZE	DESCRIPTION	LOAD CAPACITY
WMR-8U	8U	18" DEEP, RMU NUMBER MARKINGS ON RAILS	110 LBS.
WMR-15U	15U	18" DEEP, RMU NUMBER MARKINGS ON RAILS	130 LBS.
WMR-30U	30U	18" DEEP, RMU NUMBER MARKINGS ON RAILS	150 LBS.

2-POST & 4-POST OPEN FRAME FLOOR RACKS



4-POST

2-POST

PART#	U SIZE	DESCRIPTION	LOAD CAPACITY
2POST-45U	45U	7", SPCC/STEEL FRAME, #12-24 THREADED MOUNTING HOLES, NUMBER MARKING ON RAILS	1000 LBS.
4POST-45U	45U	7", STEEL, #12-24 THREADED MOUNTING HOLES, NUMBER MARKING ON RAILS, ADJUSTABLE DEPTH, EIA/ECA-310-E (REVISION OF EIA-310-D) COMPLIANT	1500 LBS.

LADDER RACK CABLE RUNWAY SYSTEM - SELECTION GUIDE FOR CABLE RUNWAY, CABINETS, CABLE MANAGEMENT, RACKS, BRACKETS AND ACCESSORY SOLUTIONS

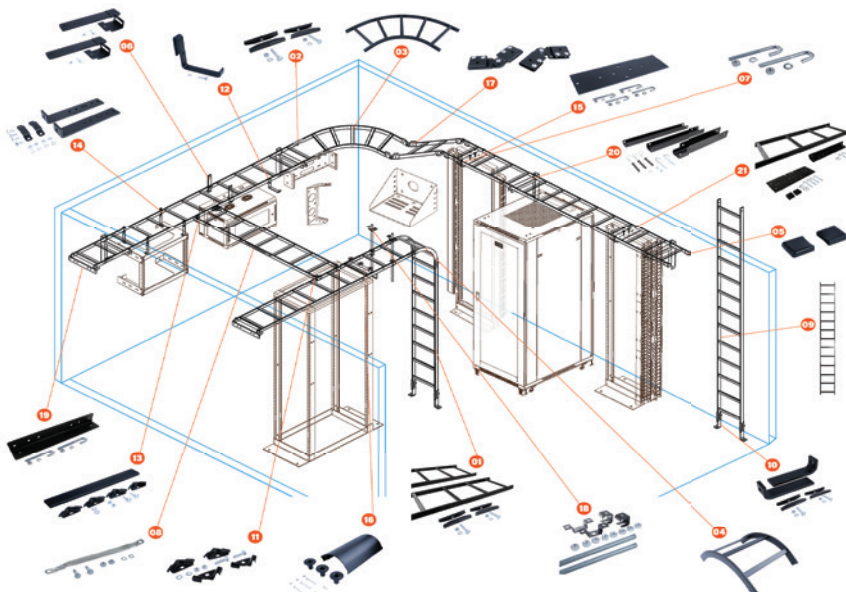

NO.	DESCRIPTION	PART#
01	5' LADDER RACK RUNWAY W/ BUTT-SPLICE KIT	WL-5SS2PC-KIT
02	BUTT-SPLICE KIT	WL-BSKTPR-BK
03	RADIUS HORIZONTAL BEND LADDER	WL-FT9012-BK
04	UNIVERSAL RADIUS BEND LADDER	WL-IR9012-BK
05	LADDER RACK END CAP	WL-LRA2EC-BK
06	RETAINING POST KIT	WL-LRA06RPK-BK
07	J-BOLT KIT (5/16")	WL-LRA300JK
08	GROUNDING STRAP WITH HARDWARE	WL-LRAGK
09	CABLE RUNWAY 10 FOOT	WL-LR1210-BK
10	FLOOR MOUNT BRACKET	WL-RA2FA-BK
11	T-JUNCTION BRACKET KIT	WL-RA2JT-BK
12	L BRACKET - CABLE RUNWAY	WL-RA5LB-BK
13	LADDER TERMINATION KIT	WL-RA12TK-BK
14	STAND-OFF ELEVATION KIT 4" - 6"	WL-RA46SK-BK
15	RACK TO RUNWAY PLATE	WL-RA123RP-BK
16	CABLE RADIUS DROP	WL-RASD-BK1
17	BUTT SPLICE KIT - SWIVEL/ADJUSTABLE	WL-RASSK-BK
18	CEILING MOUNT KIT 5/8"	WL-RATRCK-BK
19	WALL ANGLE SUPPORT BRACKET	WL-WASB12-BK
20	TRIANGLE WALL SUPPORT	WL-WSB12-BK
21	5' LADDER RACK RUNWAY BRACKET KIT	WL-R1205-KIT

SHELVES & CABLE MANAGEMENT

VERTICAL FINGER DUCT SINGLE-SIDED & DOUBLE-SIDED CABLE MANAGERS



SINGLE-SIDED / 6" DEPTH



DOUBLE-SIDED / 12" DEPTH

- PART NO. VCMC-4678S
- PART NO. VCMC-41278D

- Single sided - 4" X 6" 78", w/ hinged covers
- Double sided - 4" X 12" 78", w/ hinged covers
- Large front and rear openings
- Dual hinged covers

VERTICAL METAL SINGLE-SIDED & DOUBLE-SIDED CABLE MANAGERS



SINGLE-SIDED / 3" DEPTH



DOUBLE-SIDED / 6" DEPTH

- PART NO. VCNB-3X3X74S
- PART NO. VCNB-3X3X74D

- Easy removable hinged cover(s) provides quick access to cable
- Attached vertically onto front or rear rails 2-Post and 4-Post open frame racks
- Available in single-sided and double-sided and measures 3.6" X 3" / 6" X 74"
- Integrated plastic cable rings for proper cable management

10" RACK SHELF VENTED

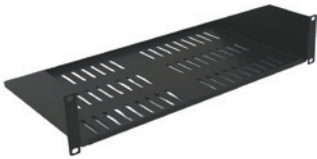

- PART NO. SHELF-10SSV
- 10" deep single-sided vented, 2U
- 16 gauge steel construction
- 50 lbs weight capacity

10" RACK SHELF SOLID



- PART NO. SHELF-10SSS
- 10" deep single-sided solid, 2U
- 16 gauge steel construction
- 50 lbs weight capacity

10" DEEP SINGLE-SIDED VENTED (2-PACK)



- PART NO. SHELF-10SSV-S2PK
- 10" deep single-sided vented, 2U, 2-PACK
- 16 gauge steel construction
- 50 lbs weight capacity

10" DEEP SINGLE-SIDED SOLID (2-PACK)



- PART NO. SHELF-10SSS-S2PK
- 10" deep single-sided solid, 2U, 2-PACK
- 16 gauge steel construction
- 50 lbs weight capacity

15" RACK SHELF VENTED



- PART NO. SHELF-15SSV
- PART NO. SHELF-14SV-1U (14" DEPTH, 1U)
- 15" deep single-sided vented, 3U
- 16 gauge steel construction
- 75 lbs weight capacity

15" RACK SHELF SOLID



- PART NO. SHELF-15SSS
- PART NO. SHELF-14SS-1U (14" DEPTH, 1U)
- 15" deep single-sided solid, 3U
- 16 gauge steel construction
- 75 lbs weight capacity

15" DEEP SINGLE-SIDED VENTED (2-PACK)

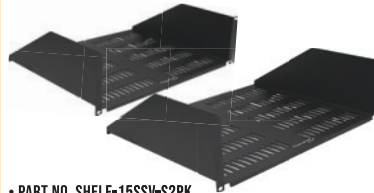

- PART NO. SHELF-15SSV-S2PK
- 15" deep single-sided vented, 3U, 2-PACK
- 16 gauge steel construction
- 75 lbs weight capacity

15" DEEP SINGLE-SIDED SOLID (2-PACK)



- PART NO. SHELF-15SSS-S2PK
- 15" deep single-sided solid, 3U, 2-PACK
- 16 gauge steel construction
- 75 lbs weight capacity

25" RACK SHELF VENTED



- PART NO. SHELF-25SSV
- 25" deep single-sided vented, 2U
- 16 gauge steel construction
- 100 lbs weight capacity

25" RACK SHELF SOLID



- PART NO. SHELF-25SSS
- 25" deep single-sided solid, 2U
- 16 gauge steel construction
- 110 lbs weight capacity

25" DEEP SINGLE-SIDED VENTED (2-PACK)

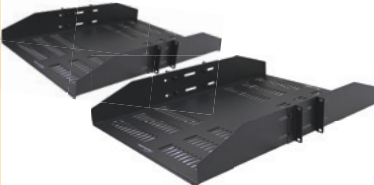

- PART NO. SHELF-25SSV-S2PK
- 25" deep single-sided vented, 2U, 2-PACK
- 16 gauge steel construction
- 100 lbs weight capacity

25" DEEP SINGLE-SIDED SOLID (2-PACK)

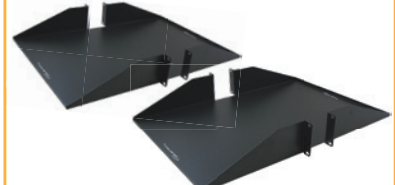

- PART NO. SHELF-25SSS-S2PK
- 25" deep single-sided solid, 2U, 2-PACK
- 16 gauge steel construction
- 110 lbs weight capacity

SHELVES & CABLE MANAGEMENT

WALL MOUNT SHELF

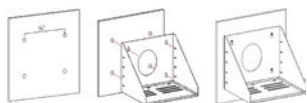

• PART NO. WMS-18

- Fully welded and made from 16-gauge steel
- Shelf bottom includes (3) 1" knockout
- Can be used with various equipment within 18" deep by 22" wide
- 140 weight capacity
- Measures: 15.3" H x 22" W x 18.2" Depth



VERTICAL & HORIZONTAL 4U WALL MOUNT BRACKET



HORIZONTAL



VERTICAL

• PART NO. VWMB-4U

- 4U, 19" wide, Vertical & horizontal wall mount bracket
- Up to 150 lbs. load capacity
- Includes mounting hardware

HIGH-DENSITY SINGLE-SIDED HORIZONTAL CABLE MANAGERS



• PART NO. MDH-1U
• PART NO. MDH-2U
• PART NO. MDH-3U

- Large slotted fingers design for high volume patch cords
- Cover comes with (4) hinges can be opened from top or bottom
- Rear openings for cable pass-through
- Measures 19" standard EIA width with 4.5" deep

WALL MOUNT HINGED BRACKETS



• PART NO. WMHB-1U
• PART NO. WMHB-2U
• PART NO. WMHB-3U
• PART NO. WMHB-4U

- 19" wide, 6" depth, Single-sided hinged
- Integrates with cable ties points
- Ideal for space restrictions area

FINGER DUCT PLASTIC HORIZONTAL CABLE MANAGERS



• PART NO. PDH-SS-1U
• PART NO. PDH-SS-2U
• PART NO. PDH-DS-1U
• PART NO. PDH-DS-2U

- Single-sided, w/ cover, 1U/2U
- Large front finger openings
- Slide-on covers

HORIZONTAL SINGLE SIDED METAL CABLE MANAGERS (MADE IN USA)



• PART NO. HCM1901-4
• PART NO. HCM1902-4

- Single-sided, 1U / 2U
- 4 / 5 horizontal rings for patch cords management
- Used with cabinets, brackets and racks
- Secure all types of low-voltage cables
- Large rings ideal for small to large cable bundles

WALL MOUNT STYLE (25-PACK)

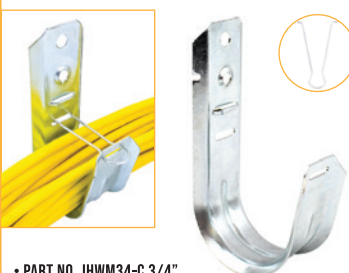

• PART NO. JHWM34-C 3/4"
• PART NO. JHWM13-C 1 5/16"
• PART NO. JHWM02-C 2"
• PART NO. JHWM04-C 4"

- Supports low-voltage cables
- Wall mount applications

MULTI-FUNCTION "BATWING" STYLE (25-PACK)



• PART NO. JHMF34-C 3/4"
• PART NO. JHMF13-C 1 5/16"
• PART NO. JHMF02-C 2"

- Supports low-voltage cables
- Attaches to threaded rod or drop wire

CEILING MOUNT STYLE (25-PACK)



• PART NO. JHCM34-C 3/4"
• PART NO. JHCM13-C 1 5/16"
• PART NO. JHCM02-C 2"
• PART NO. JHCM04-C 4"

- Supports low-voltage cables
- Designed for ceiling mount or flat surface applications

HAMMER-ON STYLE (25-PACK)



• PART NO. JHOM02-C
• CBM, 2", Fits 1/8" TO 1/4" Beam, W/Retainer Clip

- PART NO. JHOM-CLIP**
• Bottom Mount, Fits 1/8" TO 1/4" Flange Thickness

19" WIDE BLANK PANELS (5-PACK)

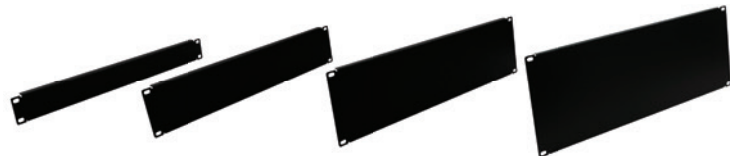

• PART NO. BP-1U-5N
• PART NO. BP-2U-5N
• PART NO. BP-3U-5N
• PART NO. BP-4U-5N

- 19" wide blank racks, cabinets & brackets panels
- Conceals Rack Mount Spaces (RMS) in racks, cabinets and brackets
- Improves aesthetic and appearance
- Available in 1U, 2U, 3U & 4U

REAR CABLE MANAGEMENT SUPPORT BARS (5-PACK)



- PART NO. RCMSB5PK**
- 19" wide
 - 5" depth rear cable management support bar
 - 5-PACK

CABLE MANAGEMENT DISTRIBUTION D-RINGS (50-PACK)



• PART NO. DR200
• PART NO. DR300
• PART NO. DR500

- Metal distribution D-ring, 50-PACK
- Organizing cables in various angles
- Indoor/outdoor applications
- Available in 2", 3" and 5" diameters

BEAM CLAMP (100-PACK)



• PART NO. BCSS

- Installation on beam flanges
- Hooks bridle rings & J-hooks
- Indoor/outdoor applications

BRIDLE RINGS (100-PACK)



• PART NO. BR100
• PART NO. BR150

- 100-PACK
- Bridle ring w/thread, 1" Diameter, #10-24 metal screw
- Bridle ring w/thread, 1 1/2" Diameter, 1/4" metal screw

RESIDENTIAL STRUCTURED WIRING ENCLOSURES

14" ENCLOSURE WITH HINGED DOOR (METAL)



- PART NO. WHWS1403
- 14" Enclosure with hinged door and screw-on option
- Wood studs or surface mountable
- Dimensions: 14" H x 14.25" W x 3.66" D
- UL Listed

18" ENCLOSURE WITH HINGED DOOR (METAL)



- PART NO. WHWS1803
- 18" Enclosure with hinged door and screw-on option
- Wood studs or surface mountable
- Dimensions: 18" H x 14.25" W x 3.66" D
- UL Listed

28" ENCLOSURE WITH HINGED DOOR (METAL)



- PART NO. WHWS2803
- 28" Enclosure with hinged door and screw-on option
- Wood studs or surface mountable
- Dimensions: 28" H x 14.25" W x 3.66" D
- UL Listed

42" ENCLOSURE WITH HINGED DOOR (METAL)



- PART NO. WHWS4203
- 42" Enclosure with hinged door and screw-on option
- Wood studs or surface mountable
- Dimensions: 42" H x 14.25" W x 3.66" D
- UL Listed

14" ENCLOSURE KIT WITH HINGED DOOR (METAL)



- PART NO. WHWS1402K
- INCL 8-Port, CAT6 data, 8 Port voice & 6-Port 2GHz video splitter modules
- Mounts between wood studs or surface mountable
- UL Listed

18" ENCLOSURE KIT WITH HINGED DOOR (METAL)



- PART NO. WHWS1802K
- INCL 8-Port, CAT6 data, 8 Port voice & 6-Port 2GHz video splitter modules
- Mounts between wood studs or surface mountable
- UL Listed

28" ENCLOSURE KIT WITH HINGED DOOR (METAL)



- PART NO. WHWS2802K
- INCL 8-Port, CAT6 data, 8 Port voice & 6-Port 2GHz video splitter modules
- Mounts between wood studs or surface mountable
- UL Listed

2GHZ 8-PORT PASSIVE VIDEO SPLITTER WITH METAL BRACKET



- PART NO. WHVS10081
- 2GHz, 1 Input x 8 Output
- Fits Wavenet's structured wiring enclosures

2GHZ 6-PORT PASSIVE VIDEO SPLITTER WITH METAL BRACKET



- PART NO. WHVS1006
- 2GHz, 1 Input x 6 Output
- Fits Wavenet's structured wiring enclosures

15" ENCLOSURE WITH TRIM RING HINGED DOOR (PLASTIC)



- PART NO. WHWS15AEP (SINGLE PACK)
- PART NO. WHWS15AEP-4PK (4-PACK, 15" W/HINGED DOOR)
- Wi-Fi friendly and eliminates interferences
- Dimensions: 15" H x 14.42" W x 3.42" D
- UL Listed

30" ENCLOSURE WITH TRIM RING HINGED DOOR (PLASTIC)



- PART NO. WHWS30AEP (SINGLE PACK)
- PART NO. WHWS30AEP-4PK (4-PACK, 30" W/HINGED DOOR)
- Wi-Fi friendly and eliminates interferences
- Dimensions: 30" H x 14.42" W x 3.42" D
- UL Listed

8-PORT CAT6 110-TYPE IDC DATA MODULE WITH PLASTIC PLATE

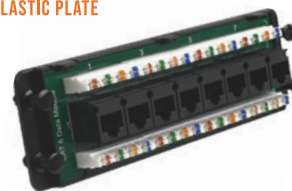

- PART NO. WHPP100805
- Supports up to 8 data connections
- Fits Wavenet's structured wiring enclosures

8-PORT BLANK PANEL



- PART NO. WPK10080
- Multiple media applications
- Configurable with keystone modular connectors
- Fits Wavenet's structured wiring enclosures

8-PORT 110-TYPE IDC VOICE MODULE WITH RJ-31X, PLASTIC PLATE



- PART NO. WHBG100806
- Supports up to 8 voice connections w/RJ31X
- Fits Wavenet's structured wiring enclosures

VOICE/DATA/VIDEO MODULE KIT



- PART NO. VDVM-8D8P6V
- (1) 8-Ports CAT6 Data, (1) 8-Ports Phone with RJ31X & (1) 6-Ports 2GHz splitter
- UL Listed and compliant with ANSI/TIA-568 standards for residential use

TOOLS & ACCESSORIES

RJ45-EZPASS® CAT5E UTP MODULAR PLUGS [100-PACK]

- PART NO. CAT5ERJ45-EZPASS
- For use with 24-26 AWG CAT5E Unshielded UTP solid and stranded cables
- High-Performance 3 Prongs Brass 8P8C and 50um gold-plated contacts
- Conductors trimmed to the correct length by the tool – no measuring



RJ-45 CAT5E MODULAR PLUGS

- PART NO. RJ45-CAT5UTP-100PK
- 100-PACK, No loading bar
- Accepts 24-23 AWG solid or stranded UTP cables



RJ-45 CAT5E MODULAR PLUGS

- PART NO. RJ45-CAT5UTP50U-100PK
- 100-PACK, CAT6 RJ45 plug w/ loading bar
- 50 micron gold contacts



RJ-45 CAT5E SHIELDED MODULAR PLUG

- PART NO. RJ45-CAT5FTP-100PK
- RJ-45, CAT5E, Shielded modular plugs

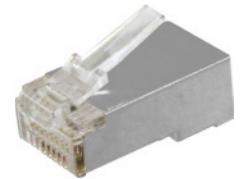

RJ45-EZPASS® CAT6 UTP MODULAR PLUGS [100-PACK]

- PART NO. CAT6RJ45-EZPASS
- For use with 23-26 AWG CAT6 Unshielded UTP solid and stranded cables
- High-Performance 3 Prongs Brass 8P8C and 50um gold-plated contacts
- Conductors trimmed to the correct length by the tool – no measuring



RJ-45 CAT6 MODULAR PLUGS

- PART NO. RJ45-CAT6UTP-100PK
- Modular plugs, No loading bar
- 100-PACK



RJ-45 CAT6 MODULAR PLUGS

- PART NO. RJ45-CAT6UTP50U-100PK
- 100-PACK, CAT6 RJ45 plug w/ loading bar
- 50 micron gold contacts
- Staggered closing reduces NEXT



RJ-45 CAT6 SHIELDED MODULAR PLUG

- PART NO. RJ45-CAT6FTP
- RJ-45, CAT6 shielded, Modular plugs
- Loading bar included



RG-6 COMPRESSION F-TYPE [50-PACK]

- PART NO. F-RG6U-50PK
- F-TYPE connectors for RG-6 coaxial cables



RJ-45 CAT6A SHIELDED MODULAR PLUGS [50U, 100-PACK]

- PART NO. RJ45-CAT6AFTP-100PK
- RJ-45, CAT6A shielded, Modular plugs
- Loading bar included



JACK4PAIR® KEYSTONE TOOL

- PART NO. TOOL-JACK4PR
- JACK4PAIR®, 4-Pair termination tool for keystone jacks



JACK4PAIR®, REPLACEMENT CUT MODULE & BASE

- PART NO. JRH90180-4PR-KSJ
- Replacement Cut Module & Base for SDJ & HDJ Keystone Jacks for JACK4PAIR®



PUNCH DOWN TOOL

- PART NO. TOOLPD-11066
- 110 & 66 punch down tool



MOD PLUG CRIMP TOOL

- PART NO. TOOL-CMBST
- 8P, 6P, 4P modular plug crimping tool



UNIVERSAL COMPRESSION TOOL

- PART NO. TOOLCOM
- Universal compression tool for F-TYPE, BNC & RCA connectors



HANDHELD UNIVERSAL KEYSTONE JACKS TERMINATION AID

- PART NO. TOOLKSJ-HLDR
- Universal keystone jacks termination tool



COMBO STRIPPER TOOL

- PART NO. TOOL-CCS
- UTP & Coax combo stripper tool



WIRE CUTTER AND STRIPPER

- PART NO. T5021
- Wire cutter and stripper tool



RJ45-EZPASS® PASS-THROUGH CRIMPING TOOL

- PART NO. TOOL-EZPASS
- RJ45-EZPASS® Crimp Tool, Pass-Through Crimper, Cutter for CAT6 & CAT5E 8P8C Modular plugs



4-PAIR PUNCH DOWN TOOL

- PART NO. T1104PR-PP
- 110 Punch Down, 4-Pair tool for patch panels



REPLACEMENT BLADE

- PART NO. TA110-RB
- Replacement blade for 110 Punch down tool



PDU

- PART NO. PDU1012M-24
- Outlet Quantity: 2 Front / 10 Rear
- Maximum Current (amps): 15A
- Single Phase AC W/6.5 FT. power cord
- 1U



<p>CALIFORNIA CORPORATE WAREHOUSE Carson, CA 90745</p>	<p>TEXAS WAREHOUSE Dallas, TX 75056</p>	<p>NEW JERSEY WAREHOUSE Ridgefield, NJ 07657</p>
---	--	---

TOLL FREE. 888.492.8363

